



GR-500XL

50 Ton Capacity (45.4 Metric Tons)

HYDRAULIC ROUGH TERRAIN CRANE

DIMENSIONS

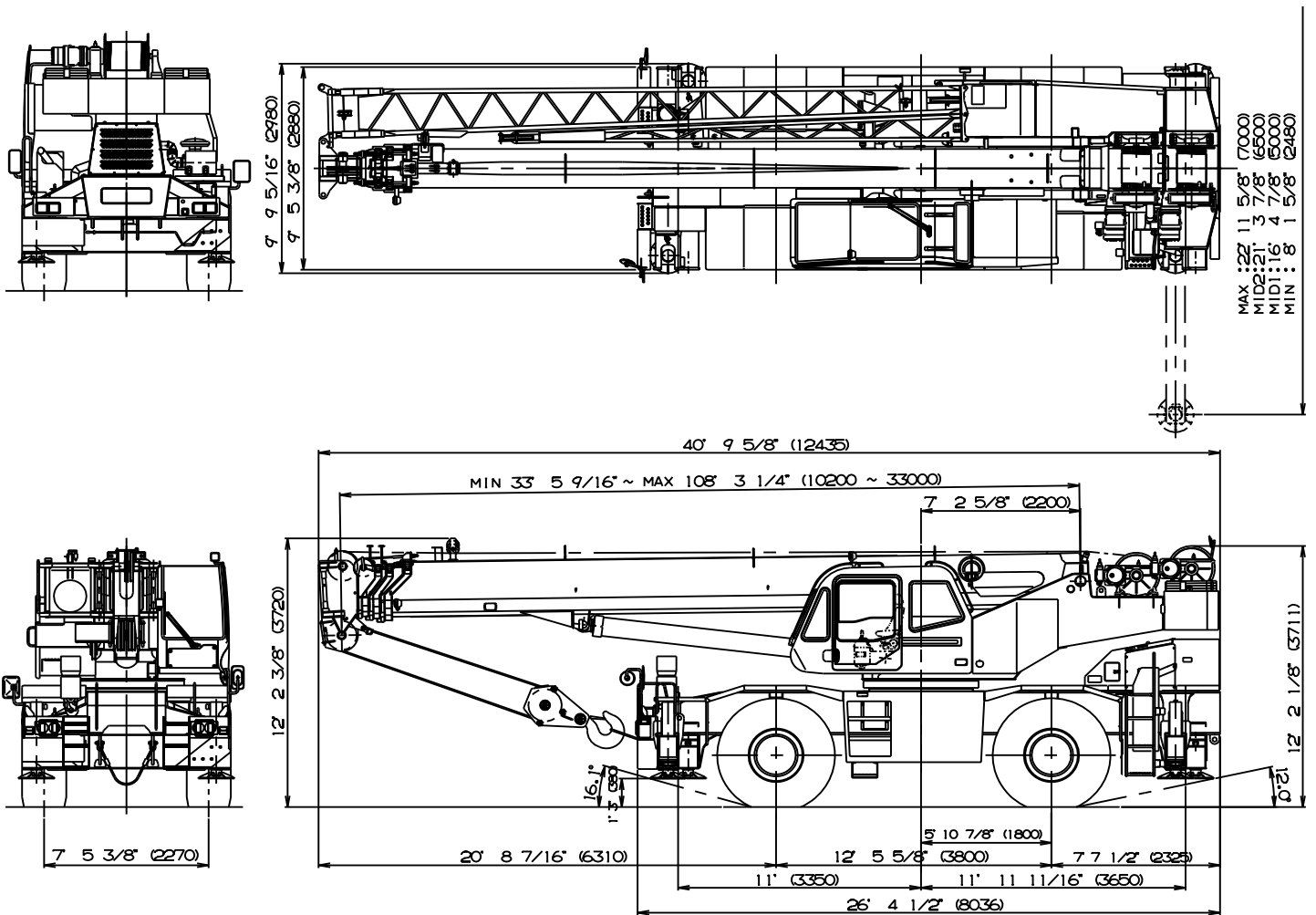

Note : Dimension is with boom angle at -0.8 degree.

GENERAL DIMENSIONS (23.5 - 25 20PR Tires)

	Feet	Meters
Turning radius		
4 wheel steer	22'	6.7
2 wheel steer	38' 4-5/8"	11.7
Tail swing of counterweight	13' 5"	4.12

Specifications are subject to change without notice.

CRANE SPECIFICATIONS

BOOM

Four section full power synchronized telescoping boom, 33.5'~108.3' (10.2m~33m), of round hexagonal box construction with four sheaves, 15-5/8" (0.396m) root diameter, at boom head. The synchronization system consists of a double acting telescope cylinder, two extension cables and retraction cables. Hydraulic cylinder fitted with holding valve. Two easily removable wire rope guards, rope dead end provided on both sides of boom head. Boom telescope sections are supported by wear pads both vertically and horizontally. Extension speed 74.8' in 69 seconds.

BOOM ELEVATION - By a double acting hydraulic cylinder with holding valve. Elevation -0.8° ~ 80° , combination controls for hand or foot operation. Boom angle indicator. Automatic speed reduction and soft stop function. Elevating speed -0.8° ~ 80° in 51 seconds.

JIB - Two stage bi-fold lattice type, 5° , 25° or 45° offset (tilt type). Single sheave, 15-5/8" (0.396m) root diameter, at base and top jib head. Stored alongside base boom section. Jib length is 28.9' (8.8m) or 50' (15.2m). Self stowing jib mounting pins.

AUXILIARY LIFTING SHEAVE (SINGLE TOP) (OPTIONAL) - Single sheave, 17-5/16" (0.44m) root diameter. Mounted to main boom head for single line work (stowable).

ANTI-TWO BLOCK - Pendant type over-winding cut out device with audio-visual (FAILURE lamp/BUZZER) warning system.

SWING

Hydraulic axial piston motor driven through planetary swing speed reducer. Continuous 360° full circle swing on ball bearing turntable at 2.7rpm. Equipped with manually locked/released swing brake. A 360° positive swing lock for pick and carry and travel modes, manually engaged in cab. Twin swing system: Free swing or lock swing controlled by selector switch on front console. Automatic speed reduction and soft stop function. (swing range restricted only)

HOIST

MAIN HOIST - Variable speed type with grooved drum driven by hydraulic axial piston motor through winch speed reducer. Power load lowering and raising. Equipped with automatic brake (neutral brake) and counterbalance valve. Controlled independently of auxiliary hoist. Equipped with cable follower and drum rotation indicator.

DRUM - Grooved 15-3/4" (0.40m) root diameter x 22-3/4" (0.578m) wide. Wire rope: 597' of 3/4" diameter rope (182m of 19mm). Drum capacity: 905' (276m) 6 layers. Maximum line pull (permissible): 14,272lbs. (6,474kg)*. Maximum line speed: 472FPM (144m/min).

AUXILIARY HOIST (OPTIONAL) - Variable speed type with grooved drum driven by hydraulic axial piston motor through winch speed reducer. Power load lowering and raising. Equipped with automatic brake (neutral brake) and counterbalance valve. Controlled independently of main hoist. Equipped with cable follower and drum rotation indicator.

DRUM - Grooved 15-3/4" (0.40m) root diameter x 22-3/4" (0.578m) wide. Wire rope: 345' of 3/4" diameter rope (105m of 19mm). Drum capacity: 905' (276m) 6 layers. Maximum line pull (permissible): 14,272lbs. (6,474kg)*. Maximum line speed: 417FPM (127m/min).

* Maximum permissible line pull may be affected by wire rope strength.

WIRE ROPE - Warrington seal wire, extra improved plow steel, preformed, independent wire rope core, right regular lay. 3/4" (19 mm) 6X37 class

HOOK BLOCKS

50 ton (45.4 metric ton) - 5 sheaves with swivel hook and safety latch, for 3/4" (19mm) wire rope. (OPTIONAL)

30 ton (27.2 metric ton) - 3 sheaves with swivel hook and safety latch, for 3/4" (19mm) wire rope. (OPTIONAL)

5.5 ton (5.0 metric ton) - Weighted hook with swivel and safety latch, for 3/4" (19mm) wire rope.

HYDRAULIC SYSTEM

PUMPS - Two variable piston pumps for crane functions. Tandem gear pump for steering, swing and optional equipment. Powered by carrier engine. Pump disconnect for crane is engaged/ disengaged by rotary switch from operator's cab.

CONTROL VALVES - Multiple valves actuated by pilot pressure with integral pressure relief valves.

RESERVOIR - 148 gallon (560 lit.) capacity. External sight level gauge.

FILTRATION - 26 micron return filter, full flow with bypass protection, located inside of hydraulic reservoir. Accessible for easy replacement.

OIL COOLER - Air cooled fan type.

CAB AND CONTROLS

Both crane and drive operations can be performed from one cab mounted on rotating superstructure.

Left side, 1 man type, steel construction with sliding door access and safety glass windows opening at side. Door window is powered control. Windshield glass window and roof glass window are shatter-resistant. Tilt-telescoping steering wheel. Adjustable control lever stands for swing, boom hoist, boom telescoping, auxiliary hoist and main hoist. Control lever stands can change neutral positions and tilt for easy access to cab. Engine throttle knob. Foot operated controls: boom hoist, boom telescoping, service brake and engine throttle. Hot water cab heater and air conditioning (OPTIONAL).

Dash-mounted engine start/stop, monitor lamps, cigarette lighter, drive selector switch, parking brake switch, steering mode select switch, power window switch, pump engaged/ disengaged switch, swing brake switch, telescoping/auxiliary winch select switch, outrigger controls, free swing / lock swing selector switch and ashtray.

Instruments - Torque converter oil temperature, engine water temperature, air pressure, fuel, speedometer, tachometer and hour meter. Hydraulic oil pressure is monitored and displayed on the AML-L display panel.

Tadano electronic LOAD MOMENT INDICATOR system (AML-L) including:

- Control lever lockout function
- Lift status indicator
- Outrigger status indicator
- Warning buzzer
- Boom angle / boom length / jib offset angle / load radius / rated lifting capacities / actual loads read out
- Ratio of actual load moment to rated load moment indication
- Automatic Speed Reduction and Soft Stop function on boom elevation and swing.(swing range restricted only)
- Working condition register switch
- Load radius / boom angle / tip height / swing range preset function
- External warning lamp

TADANO AML-L monitors outrigger extended length and automatically programs the corresponding "RATED LIFTING CAPACITIES" table.

Operator's right hand console includes transmission gear selector and sight level bubble. Upper console includes working light switch, roof washer and wiper switch, oil cooler switch, emergency outrigger set up key switch and air conditioning control switch. Swing lock lever and 3 way adjustable seat with high back and seat belt.

NOTE: Each crane motion speed is based on unladen conditions.

CARRIER SPECIFICATIONS

TYPE - Rear engine, left hand steering, 4x2 front drive or 4x4 front and rear drive, selected by 2-way manual switch.

FRAME - High tensile steel, all welded mono-box construction.

TRANSMISSION - Electronically controlled full automatic transmission. Torque converter driving full powershift with driving axle selector. 6 forward and 2 reverse speeds, constant mesh.

- 4 speeds - high range - 2 wheel drive; 4 wheel drive
- 4 speeds - low range - 4 wheel drive

TRAVEL SPEED - 31 mph (50 km/h)

AXLE - Front: Full floating type, steering and driving axle with planetary reduction. Rear: Full floating type, steering and driving axle with planetary reduction and non-spin rear differential.

STEERING- Hydraulic power steering controlled by steering wheel. Three steering modes available: 2 wheel front, 4 wheel coordinated and 4 wheel crab.

SUSPENSION - Front: Semi-elliptic leaf springs with hydraulic lockout device. Rear: Semi-elliptic leaf springs with hydraulic lockout device.

BRAKE SYSTEMS - Service: Air over hydraulic disc brakes on all 4 wheels. Parking/Emergency: Spring applied-air released brake acting on input shaft of front axle. Auxiliary: Electro-pneumatic operated exhaust brake.

TIRES - 23.5-25 20PR(OR)

OUTRIGGERS - Four hydraulic, beam and jack outriggers. Vertical jack cylinders equipped with integral holding valve. Each outrigger beam and jack is controlled independently from cab. Beams extend to 22'11-5/8" (7.0 m) center-line and retract to within 9' 10-1/8" (3.0 m) overall width with floats. Outrigger jack floats are attached thus eliminating the need of manually attach and detach them. Controls and sight bubble located in superstructure cab. Three outrigger extension lengths are provided with corresponding "RATED LIFTING CAPACITIES" for crane duty in confined areas.

- Mid. Extension 16' 4-7/8" center to center
- Mid. Extension 21' 3-7/8" center to center
- Max. extension 22' 11-5/8" center to center

Float size(Diameter) 1'7-11/16"(0.5m)

ENGINE

Model	Mitsubishi 6M60-TLA3B
Type	Direct injection diesel
No. of cylinders	6
Combustion	4 cycle, turbo charged and after cooled
BoreXStroke, in.(mm)	4.646 X 4.528 (118X115)
Displacement, cu. in (liters)	460 (7.54)
Air inlet heater	24 volt preheat
Air cleaner	Dry type, replaceable element
Oil filter	Full flow with replaceable element
Fuel filter	Full flow with replaceable element
Fuel tank, gal.(liters)	79.2 (300), right side of carrier
Cooling	Liquid pressurized, recirculating by-pass

Radiator	Fin and tube core, thermostat controlled
Fan, in.(mm)	Suction type, 6-blade, 23.6 (600) dia.
Starting	24 volt
Charging	24 volt system, negative ground
Battery	2-120 amp. Hour
Compressor, air, CFM(l /min)	29 CFM (830) at 2,600rpm
Horsepower (kW)	Gross 267 (200) at 2,600rpm
Torque, Max. ft-lb (kgm)	579 (80) at 1,400rpm
Capacity, gal.(liters)	
Cooling water	3.4 (13)
Lubrication	3.4-4.0 (13-15)
Fuel	79.2 (300)

STANDARD EQUIPMENT

- Four section full power synchronized boom 33.5'-108.3' (10.2 m-33 m)
- 28.9'-50' (8.8 m-15.2 m) bi-fold lattice jib (tilt type) with 5°, 25° or 45° pinned offsets and self storing pins.
- Variable speed main hoist with grooved drum, cable follower and 597' of 3/4" cable.
- Drum rotation indicator (thumper type) main hoist
- Anti-Two block device (overwind cutout)
- Boom angle indicator
- Tadano electronic load moment indicator system (AML-L)
- Outrigger extension length detector
- Electronic crane monitoring system
- Tadano twin swing system and 360° positive swing lock
- Self centering finger control levers with pilot control
- Control pedals for boom hoist and boom telescoping
- 3 way adjustable cloth seat with armrests, high back and seat belt
- Tilt-telescoping steering wheel
- Tinted safety glass and sun visor
- Front windshield wiper and washer
- Roof window wiper and washer
- Power window (cab door)
- Rear view mirrors (right and left side)
- Mirror for main and auxiliary hoists
- Cigarette lighter and ashtray
- Electric fan in cab
- Cab floor mat
- Pump disconnect in operator's cab
- Hydraulic oil cooler
- Independently controlled outriggers
- Three outrigger extension positions
- Self-storing outrigger pads
- Outrigger hose protection
- Mitsubishi 6M60-TLA3B turbo charged after cooled engine (267HP) with exhaust brake
- Electronic controlled automatic transmission driven by torque converter
- 4 x 4 x 4 drive/steer
- Non-spin rear differential
- Semi-elliptic leaf springs suspension with hydraulic lockout device (front and rear)
- 23.5-25 20PR (OR) tires
- Disc brakes
- Fenders
- Air dryer
- Water separator with filter
- Engine over-run alarm
- Back-up alarm
- Low oil pressure/high water temp. warning device (visual)
- Rear steer centering light
- Air cleaner dust indicator
- Full instrumentation package
- Complete highway light package
- Flood lights and work lights
- Tool storage compartment
- Tire inflation kit
- 24 volt electric system
- 5.5 ton (5.0 metric ton) hook with swivel
- Towing hooks-Front and rear
- Lifting eyes
- Hook block tie down (front bumper)
- Weighted hook storage compartment

OPTIONAL EQUIPMENT

- Variable speed auxiliary hoist with grooved drum, cable follower, drum rotation indicator and 345' of 3/4" cable.
- Auxiliary lifting sheave (single top) stowable
- 50 ton (45.4 metric ton) 4 sheave hook block
- 30 ton (27.2 metric ton) 3 sheave hook block
- Hot water cab heater and air conditioner

HOISTING SPECIFICATIONS

LINE SPEEDS AND PULLS

Layer	Speed	Main or auxiliary hoist - 15'-3/4" (0.4m) drum					
		Line speeds ²		Line pulls			
		F.P.M	m/min	Available ¹		Permissible ⁴	
				Lbs.	kgf	Lbs.	kgf
1st	High	367	112	15,698	7,121	14,272	6,474
2nd	High	400	122	14,647	6,644	13,315	6,040
3rd	High	433	132	13,520	6,133	12,292	5,576
4th	High	466	142	12,557	5,696	11,417	5,179
5th	High	502	153	11,721	5,317	10,657	4,834
6th ³	High	534	163	10,989	4,985	9,991	4,532

¹ Developed by machinery with first layer of wire rope, but not based on rope strength or other limitation in machinery or equipment.

² Line speeds based only on hook block, not loaded.

³ Sixth layer of wire rope is not recommended for hoisting operations.

⁴ Permissible line pull may be affected by wire rope strength.

DRUM WIRE ROPE CAPACITIES

Wire rope layer	Main and auxiliary drum grooved lagging			
	3/4" (19mm) wire rope			
	Rope per layer		Total wire rope	
	Feet	Meters	Feet	Meters
1	123.0	37.5	123.0	37.5
2	134.2	40.9	257.2	78.4
3	145.3	44.3	402.5	122.7
4	156.5	47.7	559.0	170.4
5	167.7	51.1	726.7	221.5
6	178.8	54.5	905.5	276.0

DRUM DIMENSIONS

	Inch	mm
Root diameter	15-3/4"	400
Length	22-3/4"	578
Flange diameter	25-3/8"	645

GR-500XL WORKING RANGE CHART

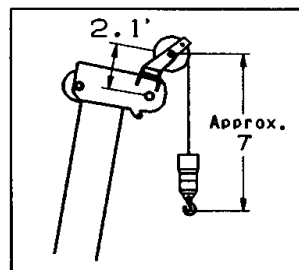
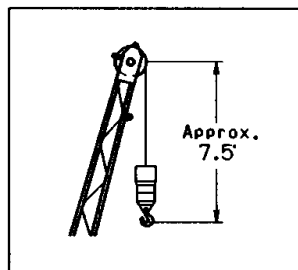
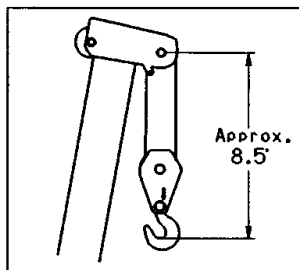
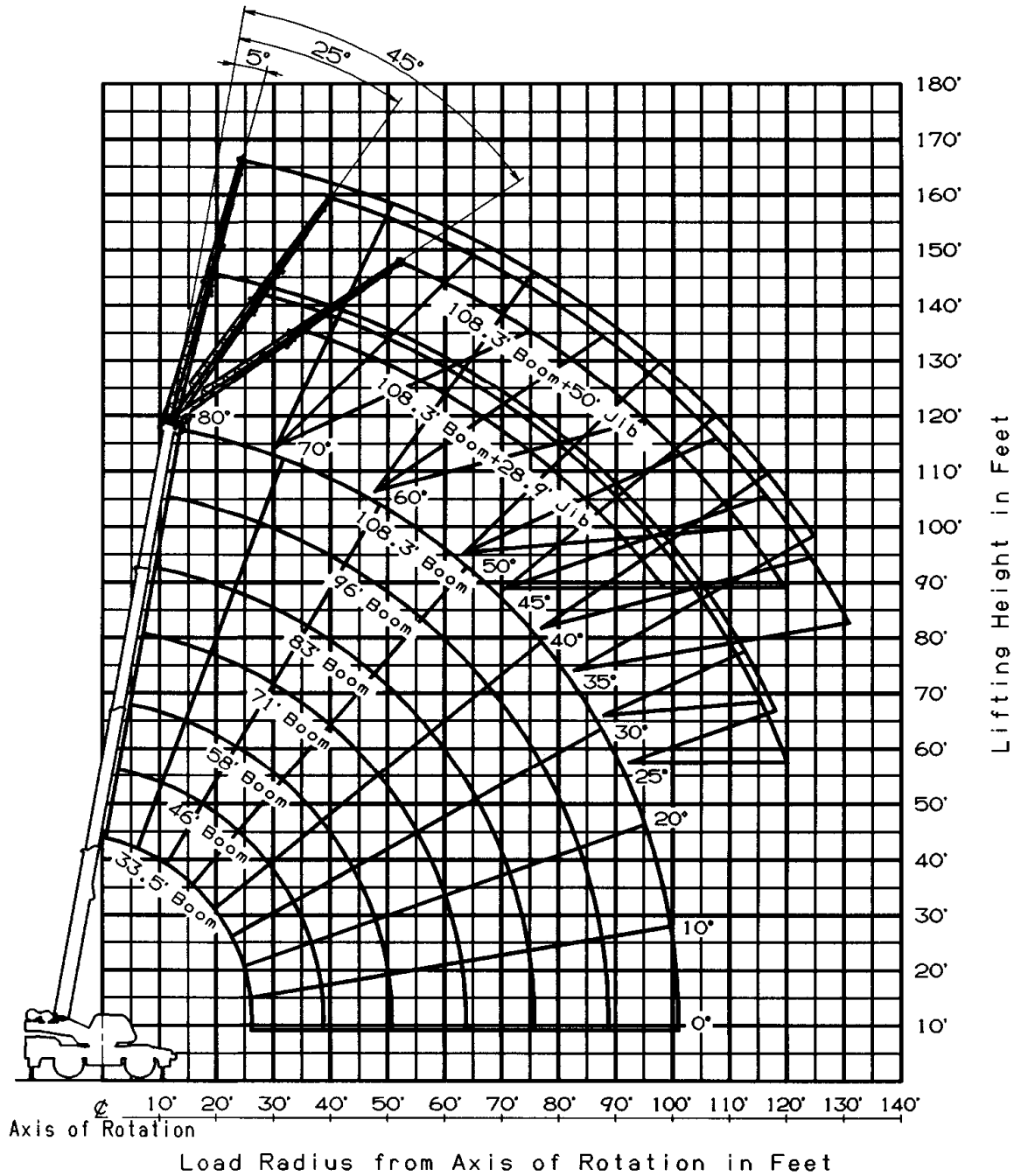

NOTE: Boom and jib geometry shown are for unloaded condition and machine standing level on firm supporting surface. Boom deflection and subsequent radius and boom angle change must be accounted for when applying load to hook.

GR-500XL RATED LIFTING CAPACITIES (IN POUNDS)

ON OUTRIGGERS FULLY EXTENDED 22' 11-5/8" (7.0m) SPREAD
360° ROTATION

A B	33.5' (10.2m)	46' (14.02m)	58' (17.68m)	71' (21.64m)	83' (25.3m)	96' (29.26m)	108.3' (33.0m)	Boom Angle in Degree	108.3' (33.0m) Boom + 28.9' (8.8m) Jib						108.3' (33.0m) Boom + 50.0' (15.2m) Jib					
									5° offset		25° offset		45° offset		5° offset		25° offset		45° offset	
									R	W	R	W	R	W	R	W	R	W		
10'	100,000	48,500	47,000	41,000																
12'	77,000	48,500	47,000	41,000	36,600															
15'	67,200	48,500	47,000	41,000	36,600	30,400		80°	19.0	9,900	28.5	8,150	35.4	6,000	24.9	5,900	40.7	4,000	52.8	2,850
20'	52,700	48,500	42,700	36,400	31,100	27,500	20,000	75°	31.5	9,900	40.0	7,200	46.9	5,700	39.4	5,900	54.5	3,500	65.3	2,550
25'	36,500	43,000	37,500	32,000	26,900	23,700	20,000	70°	43.6	8,600	51.5	6,300	57.4	5,300	52.8	4,900	67.3	3,100	76.8	2,400
30'		33,700	33,200	28,600	23,600	20,700	19,100	65°	55.1	6,900	62.3	5,500	67.3	4,850	65.9	4,100	79.4	2,850	87.6	2,300
35'		25,300	26,100	25,500	20,900	18,400	16,700	60°	65.9	5,800	72.5	4,800	76.4	4,400	78.4	3,500	90.9	2,650	97.4	2,200
40'			20,700	20,900	18,500	16,400	14,700	55°	76.1	4,900	82.0	4,150	85.3	3,950	90.2	3,000	101.1	2,350	106.6	2,100
45'			16,700	17,000	16,500	14,800	13,200	50°	85.6	4,100	90.6	3,700	93.2	3,500	100.7	2,650	110.6	2,150	114.5	1,950
50'			13,700	14,100	13,900	13,400	11,900	45°	94.2	3,500	98.4	3,100	100.1	2,850	110.6	2,250	119.1	1,950	121.7	1,800
55'				11,700	11,900	11,600	10,800	40°	101.7	2,750	105.3	2,450			119.4	1,650	126.6	1,550		
60'				10,000	10,200	10,000	9,700	35°	108.6	2,150	111.6	2,000			127.6	1,200	133.2	1,150		
65'					8,700	8,700	8,700	30°	114.8	1,650	117.1	1,650								
70'					7,300	7,300	7,600	25°	119.8	1,350	121.7	1,400								
75'					6,300	6,350	6,600													
80'						5,400	5,700													
85'						4,750	4,900													
90'							4,150													
95'							3,650													
100'							3,150													
C	0°																			

A: Boom length in feet
 B: Load radius in feet
 C: Minimum boom angle (deg.) for indicated length (no load)
 D: Loaded boom angle (deg.)
 R: Load radius in feet
 W: Rated lifting capacity in pounds

LIFTING CAPACITIES AT ZERO DEGREE BOOM ANGLE ON OUTRIGGERS FULLY EXTENDED
22' 11-5/8" (7.0m) SPREAD 360° ROTATION

A D	33.5' (10.2m)	46' (14.02m)	58' (17.68m)	71' (21.64m)	83' (25.3m)	96' (29.26m)	108.3' (33.0m)							
0°	26.2	32,200	38.7	21,500	50.7	13,400	63.6	8,900	75.6	6,200	88.7	4,200	101.0	3,100

ON OUTRIGGERS MID. EXTENDED 21' 3-7/8" (6.5m) SPREAD
360° ROTATION

A B	33.5' (10.2m)	46' (14.02m)	58' (17.68m)	71' (21.64m)	83' (25.3m)	96' (29.26m)	108.3' (33.0m)	Boom Angle in Degree	108.3' (33.0m) Boom + 28.9' (8.8m) Jib						108.3' (33.0m) Boom + 50.0' (15.2m) Jib					
									5° offset		25° offset		45° offset		5° offset		25° offset		45° offset	
									R	W	R	W	R	W	R	W	R	W		
10'	100,000	48,500	47,000	41,000																
12'	77,000	48,500	47,000	41,000	36,600															
15'	67,200	48,500	47,000	41,000	36,600	30,400		80°	19.0	9,900	28.5	8,150	35.4	6,000	24.9	5,900	40.7	4,000	52.8	2,850
20'	52,700	48,500	42,700	36,400	31,100	27,500	20,000	75°	31.5	9,900	40.0	7,200	46.9	5,700	39.4	5,900	54.5	3,500	65.3	2,550
25'	36,500	39,300	37,500	32,000	26,900	23,700	20,000	70°	43.6	8,600	51.5	6,300	57.4	5,300	52.8	4,900	67.3	3,100	76.8	2,400
30'		28,100	28,300	28,600	23,600	20,700	19,100	65°	55.1	6,900	62.3	5,500	67.3	4,850	65.9	4,100	79.4	2,850	87.6	2,300
35'		21,000	21,300	21,800	20,900	18,400	16,700	60°	65.9	5,800	72.5	4,800	76.4	4,400	78.4	3,500	90.9	2,650	97.4	2,200
40'			17,000	17,300	17,300	16,400	14,700	55°	76.1	4,500	82.0	3,850	85.3	3,850	90.2	3,000	101.1	2,350	106.6	2,100
45'			13,700	14,000	14,100	14,300	13,200	50°	85.6	3,300	90.6	2,850	93.2	2,900	100.7	2,050	110.6	1,750	114.5	1,750
50'			11,100	11,500	11,700	11,800	11,450	45°	94.2	2,350	98.4	2,000	100.1	2,050	110.6	1,350	119.1	1,150	121.7	1,150
55'				9,500	9,700	9,900	9,800	40°	101.7	1,650	105.3	1,450								
60'				8,000	8,200	8,300	8,200	35°	108.6	1,150	111.6	1,000								
65'					7,000	7,000	7,000													
70'					5,900	5,900	6,000													
75'					5,000	5,000	5,100													
80'						4,300	4,400													
85'						3,700	3,700													
90'							3,100													
95'							2,700													
100'							2,200													
C	0°																			

A: Boom length in feet
 B: Load radius in feet
 C: Minimum boom angle (deg.) for indicated length (no load)
 D: Loaded boom angle (deg.)
 R: Load radius in feet
 W: Rated lifting capacity in pounds

LIFTING CAPACITIES AT ZERO DEGREE BOOM ANGLE ON MID. EXTENDED
21' 3-7/8" (6.5m) SPREAD 360° ROTATION

A D	33.5' (10.2m)	46' (14.02m)	58' (17.68m)	71' (21.64m)	83' (25.3m)	96' (29.26m)	108.3' (33.0m)							
0°	26.2	32,200	38.7	17,600	50.7	10,900	63.6	7,300	75.6	4,900	88.7	3,300	101.0	2,200

GR-500XL RATED LIFTING CAPACITIES (IN POUNDS)

ON OUTRIGGERS MID. EXTENDED 16' 4-7/8" (5.0m) SPREAD
360° ROTATION

A B	33.5' (10.2m)	46' (14.02m)	58' (17.68m)	71' (21.64m)	83' (25.3m)	96' (29.26m)	108.3' (33.0m)	Boom Angle in Degree	108.3' (33.0m) Boom + 28.9' (8.8m) Jib						108.3' (33.0m) Boom + 50.0' (15.2m) Jib					
									5° offset		25° offset		45° offset		5° offset		25° offset		45° offset	
									R	W	R	W	R	W	R	W	R	W		
10'	100,000	48,500	47,000	41,000				80°	19.0	9,900	28.5	8,150	35.4	6,000	24.9	5,900	40.7	4,000	52.8	2,850
12'	77,000	48,500	47,000	41,000	36,600															
15'	61,300	48,500	47,000	41,000	36,600	30,400														
20'	38,500	38,200	38,200	36,400	31,100	27,500	20,000	75°	31.5	9,900	40.0	7,200	46.9	5,700	39.4	5,900	54.5	3,500	65.3	2,550
25'	24,500	25,900	25,900	26,400	26,900	23,700	20,000	70°	43.6	8,150	51.5	6,300	57.4	5,300	52.8	4,900	67.3	3,100	76.8	2,400
30'		18,600	19,000	19,400	19,800	19,600	19,100	65°	55.1	5,500	62.3	4,700	67.3	4,350	65.9	3,900	79.4	2,850	87.6	2,300
35'		13,200	14,400	14,800	15,000	15,000	15,000	60°	65.9	3,400	72.5	3,150	76.4	3,000	78.4	2,400	90.9	1,950	97.4	1,900
40'			11,200	11,700	11,900	11,900	11,900	55°	76.1	2,200	82.0	2,000	85.3	2,000	90.2	1,300	101.1	1,130	106.6	1,100
45'			8,800	9,300	9,500	9,500	9,600													
50'			7,000	7,500	7,700	7,700	7,800													
55'				6,000	6,100	6,150	6,300													
60'				4,850	5,000	5,000	5,100													
65'					4,050	4,050	4,150													
70'					3,300	3,300	3,400													
75'					2,650	2,700	2,800													
80'						2,100	2,200													
85'						1,600	1,700													
90'							1,300													
95'							900													
C				0°			22°													

A: Boom length in feet
 B: Load radius in feet
 C: Minimum boom angle (deg.) for indicated length (no load)
 D: Loaded boom angle (deg.)
 R: Load radius in feet
 W: Rated lifting capacity in pounds

LIFTING CAPACITIES AT ZERO DEGREE BOOM ANGLE ON OUTRIGGERS MID. EXTENDED 16' 4-7/8" (5.0m) SPREAD 360° ROTATION												
A	33.5'	46'	58'	71'	83'	96'						
D	B	B	B	B	B	B	B	B	B	B	B	
0°	26.2	22,700	38.7	11,600	50.7	6,900	63.6	4,300	75.6	2,600	88.7	1,400

Boom length in feet

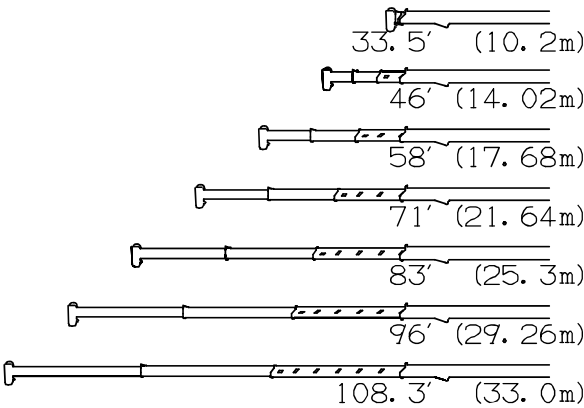

NOTE: Load radii for jib operation are given for reference with the boom fully extended to 108.3' (33m).

4,700 lbs. (2,132 kg) shall be subtracted from the rated lifting capacity of the main boom, when 28.9' jib is attached to main boom head. 28.9' jib weight is 1,250 lbs. (567 kg)

6,600 lbs. (3,000 kg) shall be subtracted from the rated lifting capacity of the main boom, when 50.0' jib is attached to main boom head. 50.0' jib weight is 1,780 lbs. (807 kg)

Standard number of parts of line for outrigger operation should be according to the following table.

Boom Length in Feet (meters)	33.5' (10.2)	33.5' to 71' (10.2 to 21.64)	71' to 108.3' (21.64 to 33.0)	Single top Jib
Number of parts of line	9	6	4	1

The lifting capacity data stored in the LOAD MOMENT INDICATOR (AML-L) is based on the standard number of parts of line listed in the chart.

Maximum lifting capacity is restricted by the number of parts of line of LOAD MOMENT INDICATOR (AML-L).

WARNING AND OPERATING INSTRUCTIONS FOR LIFTING CAPACITIES

GENERAL

1. RATED LIFTING CAPACITIES apply only to the machine as originally manufactured and normally equipped by TADANO LTD. Modifications to the machine or use of optional equipment other than that specified can result in a reduction of capacity.
2. Hydraulic cranes can be hazardous if improperly operated or maintained. Operation and maintenance of this machine must be in compliance with information in the **Operation and Maintenance Manual** supplied with the crane. If this manual is missing, order a replacement through the distributor.
3. The operator and other personnel associated with this machine shall fully acquaint themselves with the latest American National Standards Institute (ANSI) safety standards for cranes.

SET UP

1. Rated lifting capacities on the load chart are the maximum allowable crane capacities. They are based on the machine standing level on a firm supporting surface under ideal job conditions. Depending on the nature of the supporting surface, it may be necessary to have structural supports under the outrigger floats or tires to spread the loads to a larger surface.
2. For outrigger operation, outriggers shall be properly extended with tires free of supporting surface before operating crane.

OPERATION

1. Rated lifting capacities have been tested to and meet minimum requirements of SAE J1063-Cantilevered Boom Crane Structures Method of Test.
2. Rated lifting capacities do not exceed 85 % of the tipping load on outriggers fully extended as determined by SAE J765-Crane Stability Test Code. Rated lifting capacities for partially extended outriggers are determined by this formula, Rated Lifting Capacities = (Tipping Load - 0.1 x Tip Reaction)/1.25.
3. Rated lifting capacities above bold lines in the chart are based on crane strength and those below, on its stability. They are based on actual load radius increased by boom deflection.
4. The weight of load handling device such as hook blocks, slings, etc., must be considered as part of the load and must be deducted from the lifting capacities.
5. Rated lifting capacities are based on freely suspended loads and make no allowance for such factors as the effect of wind, sudden stopping of loads, supporting surface conditions, inflation of tires, operating speeds, side loads, etc. Side pull on the boom or jib is extremely dangerous.
6. Rated lifting capacities do not account for wind on lifted load or boom. We recommend against working under the condition that the load is out of control due to a strong wind. During boom lift, consider that the rated lifting capacity is reduced by 50% when the wind speed is 20mph (9m/s) to 27mph (12m/s) ; reduced by 70% when the wind speed is 27mph (12m/s) to 31mph (14m/s). If the wind speed is 31mph (14m/s) or over, stop operation. During jib lift, stop operation if the wind speed is 20mph (9m/s).
7. Rated lifting capacities at load radius shall not be exceeded. Do not tip the crane to determine allowable loads.
8. Do not operate at boom lengths, radii, or boom angle, where no capacities are shown. Crane may overturn without any load on the hook.
9. When boom length is between values listed, refer to the rated lifting capacities of the next longer and next shorter booms for the same radius. The lesser of the two rated lifting capacities shall be used.
10. When making lifts at a load radius not shown, use the next longer radius to determine allowable capacity.
11. Load per line should not exceed 11,500 lbs. (5,200kg) for main winch and 11,000 lbs. (5,000kg) for auxiliary winch.
12. Check the actual number of parts of line with LOAD MOMENT INDICATOR (AML-L) before operation. Maximum lifting capacity is restricted by the number of parts of line of LOAD MOMENT INDICATOR (AML-L). Limited capacity is as determined from the formula, Single line pull for main winch (11,500 lbs.) x number of parts of line.
13. The boom angle before loading should be greater to account for deflection.
14. The 33.5' (10.2m) boom length capacities are based on boom fully retracted. If not fully retracted [less than 46'(14.0m) boom length], use the rated lifting capacities for the 46' (14.0m) boom length.
15. Extension or retraction of the boom with loads may be attempted within the limits of the RATED LIFTING CAPACITIES. The ability to telescope loads is limited by hydraulic pressure, boom angle, boom length, crane maintenance, etc.
16. For lifting capacity of single top, reduce the rated lifting capacities of relevant boom by the mass of the main hook block. Capacities of single top shall not exceed 11,000 lbs. (5,000kg) including main hook.
17. When erecting and stowing jib, be sure to retain it by hand or by other means to prevent its free movement.
18. 4,700 lbs. (2,132 kg) shall be subtracted from the rated lifting capacity of the main boom, when 28.9' jib is attached to main boom head. 28.9' jib weight is 1,250 lbs. (567 kg) 6,600 lbs. (3,000 kg) shall be subtracted from the rated lifting capacity of the main boom, when 50.0' jib is attached to main boom head. 50.0' jib weight is 1,780 lbs. (807 kg)
19. Use Anti-two block (OVERWIND CUTOFF) disable switch when erecting and stowing jib and when stowing hook block. While the switch is pushed, the hoist does not stop, even when overwind condition occurs.
20. For boom length with 28.9' (8.8m) jib, rated lifting capacities are determined by loaded boom angle only in the column headed "108.3' (33.0m) boom + 28.9' (8.8m) jib". For boom length with 50' (15.2 m) jib, rated lifting capacities are determined by loaded boom angle only in the column headed "108.3' (33.0m) boom + 50' (15.2m) jib". For angles not shown, use the next lower loaded boom angle to determine allowable capacity.
21. When lifting a load by using jib (aux. winch) and boom (main winch) simultaneously, do the following:
 - Enter the operation status as jib operation, not as boom operation.
 - Before starting operation, make sure that mass of load is within rated lifting capacity for jib.

DEFINITIONS

1. Load Radius: Horizontal distance from a projection of the axis of rotation to supporting surface before loading to the center of the vertical hoist line or tackle with load applied.
2. Loaded Boom Angle: The angle between the boom base section and the horizontal, after lifting the rated lifting capacity at the load radius.
3. Working Area: Area measured in a circular arc about the centerline of rotation.
4. Freely Suspended Load: Load hanging free with no direct external force applied except by the hoist line.
5. Side Load: Horizontal side force applied to the lifted load either on the ground or in the air.

GR-500XL RATED LIFTING CAPACITIES (IN POUNDS)

ON RUBBER TIRE: 23.5-25 22PR									
A	Stationary						Creep		
	Over Front			360° Rotation			Over Front		
	Boom Length in Feet			Boom Length in Feet			Boom Length in Feet		
B	33.5' (10.2m)	58' (17.68m)	83' (25.3m)	33.5' (10.2m)	58' (17.68m)	83' (25.3m)	33.5' (10.2m)	58' (17.68m)	83' (25.3m)
10'	38,500			28,000			35,700		
12'	37,000	33,600		22,000	22,500		30,800	32,000	
15'	33,700	29,000		16,900	17,500		25,200	26,400	
20'	25,500	22,500	18,700	9,900	10,500	10,800	18,500	20,000	18,700
25'	17,400	17,800	16,000	6,100	6,900	7,300	14,100	15,400	15,800
30'		13,100	12,700		4,700	5,100		12,100	12,700
35'		10,000	9,600		3,100	3,500		10,000	9,600
40'		7,800	7,500		2,000	2,300		7,800	7,500
45'		6,100	5,700		1,100	1,400		6,100	5,700
50'		5,000	4,500					5,000	4,500
55'			3,500						3,500
60'			2,700						2,700
65'			2,100						2,100
70'			1,650						1,650
75'			1,200						1,200
C	0°			30°		51°	0°		

LIFTING CAPACITIES AT ZERO DEGREE BOOM ANGLE ON RUBBER OPERATION														
A	Stationary						Creep							
	Over Front			360° Rotation			Over Front							
	33.5'	58'	83'	33.5'			33.5'	58'	83'					
D	B	B	B	B			B	B	B					
	(10.2m)	(17.68m)	(25.3m)	(10.2m)			(10.2m)	(17.68m)	(25.3m)					
0°	26.2	#####	50.7	4,700	75.6	1,100	26.2	5,500	26.2	13,100	51	4,700	75.6	1,100

- A: Boom length in feet
- B: Load radius in feet
- C: Minimum boom angle (deg.) for indicated length (no load)
- D: Loaded boom angle (deg.)

Boom length in feet

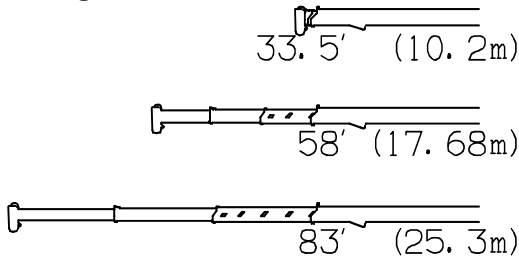

Working area

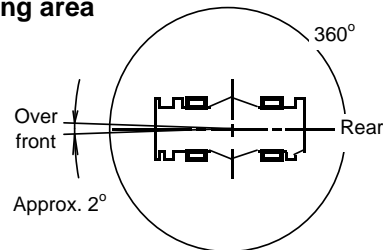

NOTE: Standard number of parts of line for on rubber operation should be according to the following table. The lifting capacity data stored in the LOAD MOMENT INDICATOR (AML-L) is based on the standard number of parts of line listed in the chart.

Boom mode	Boom	Single top
Number of parts of line	4	1

WARNING AND OPERATING INSTRUCTIONS FOR ON RUBBER LIFTING CAPACITIES

- Rated lifting capacities on rubber are in pounds and do not exceed 75 % of tipping loads as determined by SAE J765-Crane Stability Test Code.
- Rated lifting capacities shown in the chart are based on condition that crane is set on firm level surfaces with suspension lock applied. Those above bold lines are based on tire capacity and those below, on crane stability. They are based on actual load radius increased by tire deformation and boom deflection.
- If the suspension lock cylinders contain air, the axle will not be locked completely and rated lifting capacities may not be obtainable. Bleed the cylinders according to the operation safety and maintenance manual.
- Rated lifting capacities are based on proper tire inflation, capacity and condition. Damaged tires are hazardous to safe operation of crane.
- Tires shall be inflated to correct air pressure.
- Over front operation shall be performed within two degrees in front of chassis.
- On rubber lifting with "jib" is not permitted. Maximum permissible boom length is 83 ft. (25.3m).
- When making lift on rubber (stationary), set parking brake.
- For creep operation, boom must be centered over front of machine, swing lock engaged, and load restrained from swinging. Travel slowly and keep the lifted load as close to the ground as possible, and especially avoid any abrupt steering, accelerating or braking.
- Do not operate the crane while carrying the load.
- Creep is motion for crane not to travel more than 200 ft. (60 m) in any 30 minute period and to travel at the speed of less than 1 mph (1.6 km/h).
- For creep operation, set drive select switch to "4-WHEEL (Lo)" and set gear shift lever to "1".

Tires	Air Pressure
23.5-25 20PR	68 psi. (4.75kgf/cm ²)

WARNING AND OPERATING INSTRUCTIONS FOR USING THE LOAD MOMENT INDICATOR (AML-L)

1. When operating crane on outriggers:
 - Before outrigger operation, the suspension lock operation must be performed. Suspension lock system can only be performed in the over-front area.
 - Push and hold the suspension lock switch to the "LOCK" position until suspension lock lamp changes from flashing to a solid light and the suspension is fully retracted. (Outrigger and crane operations cannot be performed until suspension lock operation has been completed.)
 - Set P.T.O. switch to "ON".
 - Extend the outriggers and level the crane.
 - Press the outrigger mode select key to register for the outrigger operation. Press the register key, then the outrigger mode indicative symbol changes from flashing to a solid light.
 - Press the lift mode select key to select the lift status that corresponds to the actual boom configuration. Each time the lift mode select key is pressed, the status changes. Press the register key to register the lift status, then the lift indicative symbol changes from flashing to a solid light.
 - When mounting and stowing jib, select the jib set status. (The jib state indicative symbol will be flashing.)
2. When operating crane on rubber:
 - Before on rubber operation, the suspension lock operation must be performed. Suspension lock system can only be performed in the over-front area.
 - Push and hold the suspension lock switch to the "LOCK" position until suspension lock lamp changes from flashing to a solid light and the suspension is fully retracted. (Crane operations cannot be performed until suspension lock operation has been completed.)
 - Set P.T.O. switch to "ON".
 - Press the outrigger mode select key. The on rubber mode indicative symbol comes on. Each time the outrigger mode select key is pressed, the status changes. When the stationary operation is selected, the on rubber status symbol will be a solid light. When the creep operation is selected, the on rubber status symbol will be a flashing light.
- Press the boom mode select key to select the boom status that corresponds to the actual boom configuration. Pay attention to the following :
 - (1) For stationary operation :
 - The front capacities are attainable only when the over front position symbol comes on. When the boom is more than 1 degree from centered over front of chassis, 360° capacities are in effect.
 - When a load is lifted in the front position and then swung to the side area, make sure the value of the LOAD MOMENT INDICATOR(AML-L) is below the 360° lifting capacity.
 - (2) For creep operation :
 - The creep capacities are attainable only when boom is in the straight forward position of chassis and the over front position symbol is on. If boom is not in the straight forward position of chassis, never lift load.
3. A swing does not automatically stop even if the crane becomes overloaded.
4. During crane operation, make sure that the displays on front panel are in accordance with actual operating conditions.
5. The displayed values of LOAD MOMENT INDICATOR (AML-L) are based on freely suspended loads and make no allowance for such factors as the effect of wind, sudden stopping of loads, supporting surface conditions, inflation of tires, operating speed, side loads, etc. For safe operation, it is recommended when extending and lowering boom or swinging, lifting loads shall be appropriately reduced.
6. LOAD MOMENT INDICATOR (AML-L) is intended as an aid to the operator. Under no condition should it be relied upon to replace use of capacity charts and operating instruction. Sole reliance upon LOAD MOMENT INDICATOR(AML-L) aids in place of good operating practice can cause an accident. The operator must exercise caution to assure safety.

GR-500XL Axle weight distribution chart

	Pounds			Kilograms		
	GVW	Front	Rear	GVW	Front	Rear
Base machine	72,550	35,390	37,160	32,902	16,051	16,851
Remove:						
1. Auxiliary hoist with 345' (105m) of 3/4" (19mm)	-1,830	440	-2,270	-830	200	-1,030
2. 5.5 ton (5.0 metric ton) hook ball	-290	-410	120	-132	-186	54
3. Top jib (21')	-530	-600	70	-240	-272	32
4. Base jib (28.8')	-1,250	-2,070	820	-567	-939	372
5. EXT. Counter weight	-1,760	890	-2,650	-798	404	-1,202
Option:						
1. Auxiliary lifting sheave	150	390	-240	68	177	-109
2. 50 ton (45.4 metric ton) hook block	787	1,367	-580	357	620	-263
3. 30 ton (27.2 metric ton) hook block	630	1,090	-460	285	494	-209
4. Hot water cab heater and air conditioner	220	70	150	100	32	68

