

Lifting Capacities

Telescopic Boom All Terrain Crane

ATC-3130

130-ton (118 metric ton)

Boom and fly capacities for this machine are listed by the following sections:

Fully Extended Outriggers

- Working Range Diagram (55,115 lbs., Counterweight)
- 42' to 167' 4" (12.8 – 51.0 m) main boom capacities
- 31.1' to 53.2' (9.5 to 16.2 m) two-piece offset fly capacities
- 79.1' (24.1 m) offset fly plus 24.6' (7.5 m) tubular jib extension capacities
- 98.8' (30.1 m) offset fly plus 19.7' (6.0 m) and 24.6' (7.5 m) tubular jib extension capacities

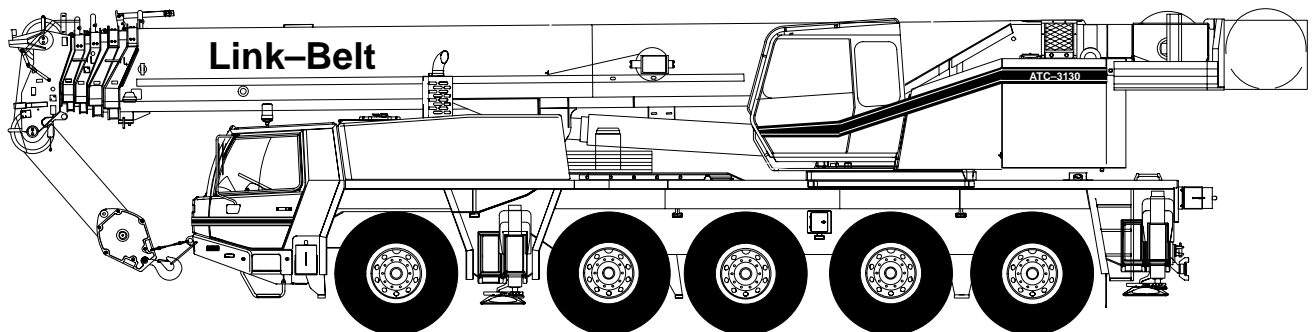

CAUTION: This material is supplied for reference use only. Operator must refer to in-cab Crane Rating Manual to determine allowable machine lifting capacities and operating procedures.



WARNING

READ AND UNDERSTAND THE OPERATOR'S AND SAFETY MANUALS AND THE FOLLOWING INSTRUCTIONS AND RATED LIFTING CAPACITIES BEFORE OPERATING THE CRANE. OPERATION WHICH DOES NOT FOLLOW THESE INSTRUCTIONS MAY RESULT IN AN ACCIDENT.

OPERATING INSTRUCTIONS

GENERAL:

1. Total rated loads shown on the LOAD RATING CHARTS apply only to the crane as originally manufactured and equipped. Modifications to the crane or use of optional equipment other than that specified can result in a reduction of capacity.
2. Construction equipment can be dangerous if improperly operated or maintained. Operation and maintenance of this crane must be in compliance with the information in the Operation and Maintenance, Parts, and Safety manuals supplied with the crane. If any manual is missing, order replacements through the distributor.
3. The operator and other personnel associated with this crane shall read and fully understand the latest applicable American National Standards ASME B30.5 safety standards for cranes.

SET UP:

1. Total rated loads shown on the LOAD RATING CHARTS are the maximum allowable crane capacities and are based on the crane standing level on firm supporting surface under ideal job conditions. Depending on the nature of the supporting surface, it may be necessary to have structural supports under the outrigger pontoons to spread the load to a larger bearing surface.
2. For on outrigger operation, outriggers shall be extended to the dimension according to the LOAD RATING CHARTS and secured by pins with tires free of supporting surface, before operating crane.
3. Lifting on tires and traveling with load is not allowed.
4. The weight of the auxiliary winch is taken into account as a part of counterweight. Therefore the auxiliary winch, or equivalent counterweight, must always be attached at the upper for crane operation.

OPERATION:

1. Total rated loads with outriggers fully extended do not exceed 85% of the tipping loads. Total rated loads with outriggers intermediate extended are determined from the formula: total rated load = (tipping load - 0.1 tip reaction) / 1.25. Tipping loads are determined by SAE crane stability test code J-765.
2. The crane's structural steelwork is in accordance with DIN 15018, part 3. Design and construction of the crane comply with DIN 15018, part 2 and with F.E.M. regulations.
3. Total rated loads above the bold lines in the LOAD RATING CHARTS are based on crane strength and have been tested to meet minimum requirements of SAE J-1063. Rated loads below the bold lines are based on crane stability.
4. Total rated loads include the weight of the main hook block, auxiliary hook ball, slings, and other auxiliary lifting devices,

and all their weights shall be subtracted from the listed capacities to obtain the net load to be lifted.

5. Total rated loads are based on freely suspended loads and make no allowance for such factors as the effect of wind, sudden stopping of loads, supporting surface conditions, operating speeds, side loads, etc. Side pull on boom or fly jib is extremely dangerous.
6. Total rated loads do not account for wind on lifted load or boom. Total rated loads and boom length shall be appropriately reduced, when wind velocity is above 18 mph (26 ft/sec.) for main boom operation and above 11 mph (16 ft/sec.) for fly jib operation.
7. Total rated loads at load radius shall not be exceeded. Do not tip the crane to determine allowable loads.
8. Do not operate at boom lengths beyond radii or boom angles where no capacities are shown. Crane may overturn without any load on the hook.
9. Swinging of the upper is admissible only when the crane is supported on intermediate or fully extended outriggers.
10. The lifting capacity ratings specified in the LOAD RATING CHARTS apply to the telescopic boom without extendable fly jib fixed in transport position or working position. If the extendable fly jib is secured to the telescopic boom in transport position or working position, the lifting capacities of the telescopic boom shall be reduced by the values specified, see Capacity Deductions. The weight of the extendable fly jib (3,650 lb) is detected in terms of a load, and the load moment limiter will shut off earlier.
11. For main boom capacities when either boom length or radius or both are between values listed, proceed as follows:
 - a. For boom lengths not listed, use rating for next longer boom length or next shorter boom length, whichever is smaller.
 - b. For load radii not listed, use rating for next larger radius.
12. The loaded boom angle combined with the boom length give only an approximation of the operating radius. The boom angle, before loading, should be greater to account for deflection.
13. The 41.99 ft boom length capacities are based on the telescopic boom being fully retracted. If not fully retracted, use the total rated loads for the 57.41 ft boom length according to the telescoping sequence.
14. Extension or retraction of the telescopic boom with loads may be attempted within the limits of the LOAD RATING CHARTS. The ability to telescope loads is limited by hydraulic pressure, boom angle, boom length, crane maintenance, etc.
15. When erecting or stowing the extendable fly jib, be sure to retain it by hand lines or by other means to prevent its free movement.
16. Use the Anti-Two Block (OVERWIND CUTOUT) disable switch when erecting or stowing the extendable fly jib and

- stowing the hook block. While the switch is pushed, the hoist will not stop, even when an overwind condition occurs.
17. The working radius specified in the LOAD RATING CHARTS for the extendable fly jib apply only if the telescopic boom is extended according to the LOAD RATING CHARTS. If one or more elements of the telescopic boom are retracted partially or completely, the specified boom angles will be decisive in determining total rated lifting capacities.
 18. When lifting a load using the extendable fly jib (auxiliary hoist) and telescopic boom (main hoist) simultaneously, do the following:
 - a. Select the correct program for the load moment device in accordance with fly jib length, fly jib offset angle, counterweight, and outrigger base.
 - b. Before starting operation, make sure that the weight of the load is within the total rated load for the extendable fly jib.
 19. Safe Load Indicator (S.L.I.)

Before working with the telescopic boom or extendable fly jib, make sure that the S.L.I. code is set to match the desired telescoping sequence. In order to set or change the S.L.I. code number, the boom must be fully retracted.
 20. Safe Load Indicator Program for Rigging Counterweight

After setting the S.L.I. code 999, the S.L.I. rigging program is activated for lifting the counterweight parts from a trailer or from the ground. This rigging program is based on intermediate extended outriggers (= 16.40 ft), on a minimum counterweight of 0 lb, and up to a maximum boom length of 73.16 ft with extendable fly jib fixed in transport position. Therefore all parts of counterweight can be lifted by the crane on itself and placed on the carrier for rigging the counterweight.
 21. Working with Single Top (Auxiliary Lifting Sheave)

Operation with the single top is allowed with the main winch and the auxiliary winch (2nd winch). The maximum allowed capacity is limited by the selected S.L.I. code for main boom operation according to existing counterweight and outrigger base at one side and by the single line pull which is limited by hydraulic pressure at the other side.

For operations with the single top mounted, use the LOAD RATING CHARTS for the telescopic boom in accordance with existing counterweight and outrigger base to find the total rated lifting capacity and also select the correct S.L.I. code for the telescopic boom in accordance with the existing counterweight and outrigger base. Find the total rated lifting capacity based on boom length and working radius. From that value, subtract 1,100 lb and the weights of all lifting equipment used including hook block, slings, and other auxiliary lifting devices. The result (<total rated lifting capacity> – <1,100 lb> – <lifting equipment>) is the total rated lifting capacity for a single top lift.

DEFINITIONS:

1. Working Radius: Horizontal distance from a projection of the axis of rotation to supporting surface before loading to the center of the vertical hoist line or tackle with load applied. The deflection of the boom due to its own weight and the rated load are taken into account.
2. Loaded Boom Angle: \angle The angle between the boom base section and horizontal, after lifting the total rated load at the working radius.
3. Working Area: Area measured in a circular arc about the centerline of rotation.
4. Freely Suspended Load: Load hanging free with no direct external force applied except by the hoist line.
5. Side Load: Horizontal side force applied to the lifted load either on the ground or in the air.

SAFE LOAD INDICATOR (PAT PDC 350):

The Safe Load Indicator (PAT PDC 350) is intended as an aid to the operator. Under no condition should it be relied upon to replace use of LOAD RATING CHARTS and Operating Instructions. Sole reliance upon the Safe Load Indicator Aids in place of good operating practice can cause an accident. The operator must exercise caution to assure safety.

PONTOON LOADINGS

| | |
|------------------------------|---|
| Maximum Pontoon Load: | Maximum Pontoon Ground Bearing Pressure: |
| 163,000 lb | 359 psi |

WINCH PERFORMANCE

| Wire Rope Layer | Winch Line Pulls (Lb) | Drum Capacity (Ft.) | |
|-----------------|------------------------------------|---------------------|-------|
| | Available (Low Speed & High Speed) | Layer | Total |
| 1 | 20,457 | 169 | 169 |
| 2 | 18,996 | 182 | 351 |
| 3 | 17,729 | 195 | 546 |
| 4 | 16,621 | 208 | 754 |
| 5 | 15,644 | 221 | 974 |
| 6 | 14,775 | 234 | 1,208 |
| 7 | 13,997 | 247 | 1,455 |

WIRE ROPE CAPACITY

| Maximum Lifting Capacities Based On Wire Rope Strength | | |
|--|-------------------|---|
| Parts Of Line | 0.83" Rope (21mm) | Notes |
| 1 | 16,680 | Capacities shown are in pounds and working loads must not exceed the ratings on the capacity charts in the Crane Rating Manual. |
| 2 | 33,360 | |
| 3 | 50,040 | |
| 4 | 66,720 | |
| 5 | 83,400 | Capacity deducts for auxiliary lifting devices do not apply for wire rope strength capacities. |
| 6 | 100,080 | |
| 7 | 116,760 | Study Operator's Manual for wire rope inspection procedures and single part of line applications. |
| 8 | 133,440 | |
| 9 | 150,120 | |
| 10 | 166,800 | |
| 11 | 183,480 | |
| 12 | 200,160 | |
| 13 | 216,840 | |
| 14 | 233,520 | |
| 15 | 250,200 | |
| 16 | 266,880 | |
| DESCRIPTION | | |
| 35 X 7 ROTATION RESISTANT – 1770 STRENGTH – RIGHT LANG LAY | | |

HYDRAULIC CIRCUIT PRESSURE SETTINGS

| Function | Pressure (psi) |
|--------------------------------------|----------------|
| Front And Rear Winch Hoisting | 4,640 |
| Front And Rear Winch Lowering | 1,450 |
| Boom Hoist Extend | 4,640 |
| Boom Hoist Retract | 500 |
| Telescope Extend | 3,330 |
| Telescope Retract | 2,400 |
| Counterweight Cylinder Rotate & Lift | 3,620 |
| Swing | 4,060 |
| Pilot Control | 580 |
| Outriggers / Suspension | 3,620 |
| Outrigger Beam Extend/Retract | 1,740 |
| Steering | 1,890 |

WORKING AREAS

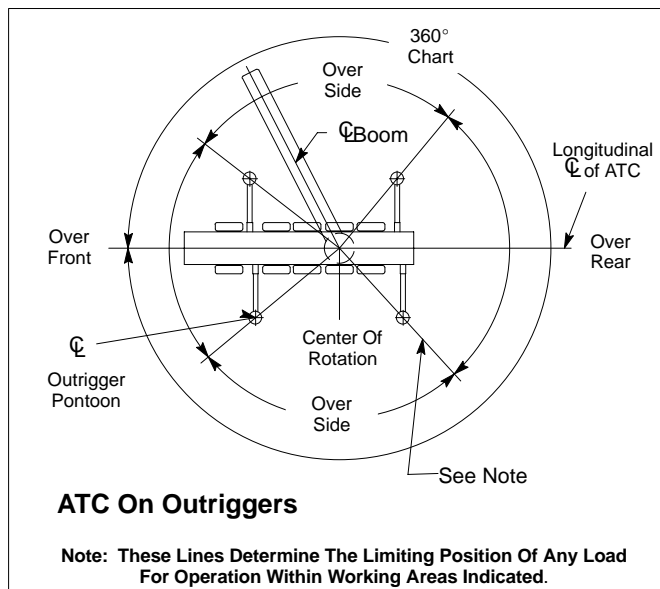

CAPACITY DEDUCTIONS

| Load Handling Equipment | Weight (lb) |
|---|-------------|
| 27.5 Ton Hook Block (See Hook Block For Actual Weight) | 660 |
| 69.5 Ton Hook Block (See Hook Block For Actual Weight) | 1,370 |
| 88.0 Ton Hook Block (See Hook Block For Actual Weight) | 1,765 |
| 130.0 Ton Hook Block (See Hook Block For Actual Weight) | 2,500 |
| 8.8 Ton Hook Ball (See Hook Ball For Actual Weight) | 440 |

LOAD RATING REDUCTION FOR THE TELESCOPIC BOOM WITH MOUNTED FLY JIB

| Position Of The Fly Jib | Boom Length (ft) | | | | | | | | |
|--|-----------------------------|-------|-------|-------|--------|--------|--------|--------|--------|
| | 41.99 | 57.41 | 73.16 | 88.91 | 104.66 | 120.41 | 135.83 | 151.57 | 167.32 |
| | Load Rating Reduction (ton) | | | | | | | | |
| 31.17 ft / 53.15 ft fly jib, mounted in transport position | 0.66 | 0.29 | 0.29 | 0.19 | 0.19 | 0.14 | 0.14 | 0.12 | 0.11 |
| 31.17 ft fly jib, mounted to the boom head | 2.59 | 2.12 | 1.94 | 1.84 | 1.80 | 1.73 | 1.70 | 1.68 | 1.61 |
| 53.15 ft fly jib, mounted to the boom head | 3.20 | 2.59 | 2.24 | 2.07 | 2.02 | 1.89 | 1.85 | 1.78 | 1.71 |
| 79.07 ft fly jib, mounted to the boom head | 5.18 | 3.77 | 3.23 | 2.94 | 2.87 | 2.63 | 2.63 | 2.44 | 2.32 |
| 98.75 ft fly jib, mounted to the boom head | 7.06 | 4.99 | 4.30 | 3.78 | 3.67 | 3.33 | 3.33 | 3.11 | 2.88 |

WORKING RANGE DIAGRAM

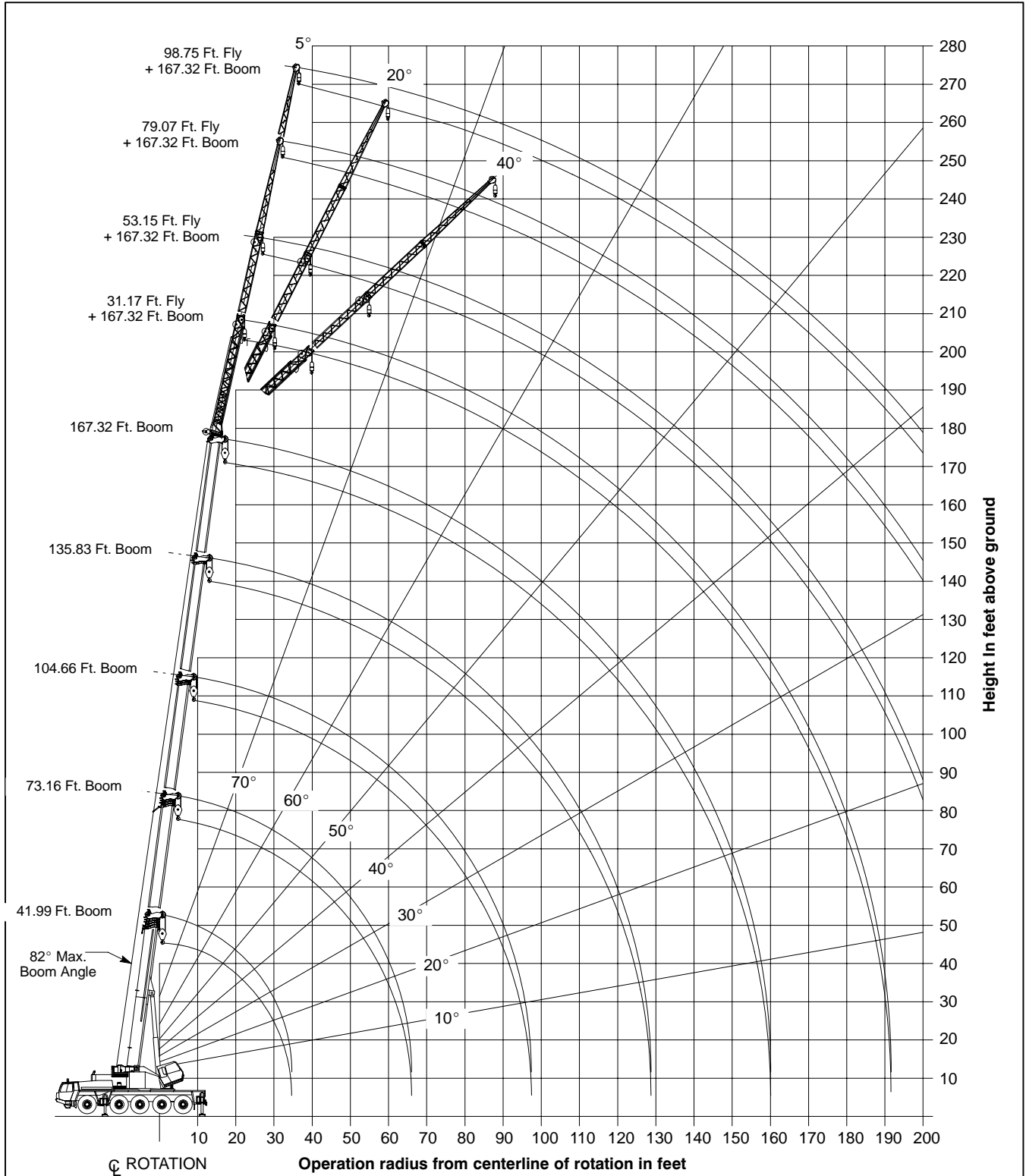

Note: Boom and fly geometry shown are for unloaded condition and crane standing level on firm supporting surface. Boom deflection, subsequent radius, and boom angle change must be accounted for when applying load to hook.



WARNING

Do Not Lower The Boom Below The Minimum Boom Angle For No Load Stability As Shown In The Lift Charts For The Boom Lengths Given. Loss Of Stability Will Occur Causing A Tipping Condition.

Rated Lifting Capacities In 1,000 Pounds

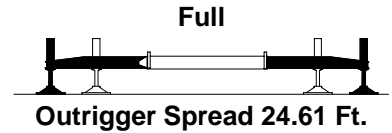
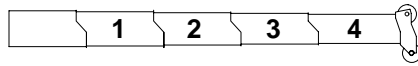
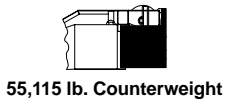

Set Up Code #015

| Load Radius (Ft.) | 41.99 Ft. | |
|-------------------------------|------------|------------|
| | \angle ° | See Note 1 |
| 10 | 68 | 260.0* |
| 12 | 65 | 222.5 |
| 14 | 62 | 203.0 |
| 16 | 59 | 180.5 |
| 18 | 55 | 161.0 |
| 20 | 51 | 143.0 |
| 25 | 42 | 113.0 |
| 30 | 28 | 91.5 |
| Telescoping sequence % | | |
| Tel. 1 | | 0 |
| Tel. 2 | | 0 |
| Tel. 3 | | 0 |
| Tel. 4 | | 0 |

Notes:

1. Over rear with superstructure pin engaged.

* – With additional equipment.

Set Up Code #010

| Load Radius (Ft.) | 41.99 Ft. | | 73.16 Ft. | | 88.91 Ft. | | 104.66 Ft. | |
|-------------------------------|------------|-------|------------|-------|------------|-------|------------|------|
| | \angle ° | 360° | \angle ° | 360° | \angle ° | 360° | \angle ° | 360° |
| 10 | 68 | 227.0 | 77 | 145.5 | | | | |
| 12 | 65 | 193.5 | 75 | 145.5 | 78 | 104.0 | | |
| 14 | 62 | 176.0 | 73 | 145.5 | 77 | 104.0 | | |
| 16 | 59 | 160.5 | 72 | 139.0 | 76 | 104.0 | 79 | 80.0 |
| 18 | 55 | 148.0 | 71 | 130.5 | 75 | 104.0 | 78 | 80.0 |
| 20 | 51 | 136.5 | 66 | 108.0 | 71 | 101.5 | 75 | 80.0 |
| 25 | 42 | 112.5 | 62 | 86.7 | 68 | 86.9 | 72 | 77.2 |
| 30 | 28 | 91.5 | 57 | 66.1 | 64 | 66.6 | 69 | 67.0 |
| 35 | | | 51 | 52.6 | 60 | 53.2 | 66 | 53.2 |
| 40 | | | 46 | 42.8 | 56 | 43.3 | 63 | 43.7 |
| 45 | | | 40 | 35.4 | 52 | 35.8 | 60 | 36.3 |
| 50 | | | 33 | 29.3 | 48 | 29.8 | 56 | 30.2 |
| 55 | | | 24 | 23.9 | 43 | 24.8 | 52 | 25.0 |
| 60 | | | | | 38 | 20.6 | 48 | 21.0 |
| 65 | | | | | 31 | 17.3 | 45 | 17.6 |
| 70 | | | | | 23 | 14.4 | 40 | 14.7 |
| 75 | | | | | 14 | 11.7 | 36 | 12.2 |
| 80 | | | | | | | 30 | 10.1 |
| 85 | | | | | | | 23 | 8.2 |
| 90 | | | | | | | 13 | 6.3 |
| 95 | | | | | | | | |
| Telescoping sequence % | | | | | | | | |
| Tel. 1 | 0 | | 100 | | 100 | | 100 | |
| Tel. 2 | 0 | | 0 | | 50 | | 100 | |
| Tel. 3 | 0 | | 0 | | 0 | | 0 | |
| Tel. 4 | 0 | | 0 | | 0 | | 0 | |

Set Up Code #010

| Load Radius (Ft.) | 120.41 Ft. | | 135.83 Ft. | | 151.57 Ft. | | 167.32 Ft. | |
|-------------------------------|------------|------|------------|------|------------|------|------------|------|
| | \angle ° | 360° | \angle ° | 360° | \angle ° | 360° | \angle ° | 360° |
| 20 | 80 | 48.5 | | | | | | |
| 25 | 77 | 48.5 | 80 | 48.5 | | | | |
| 30 | 75 | 48.5 | 78 | 48.5 | 80 | 36.4 | 81 | 31.5 |
| 35 | 72 | 48.5 | 75 | 48.5 | 77 | 36.4 | 79 | 31.5 |
| 40 | 70 | 48.1 | 73 | 47.4 | 76 | 36.3 | 78 | 31.5 |
| 45 | 67 | 44.7 | 70 | 45.9 | 73 | 35.8 | 76 | 31.1 |
| 50 | 65 | 38.5 | 68 | 39.8 | 72 | 35.0 | 74 | 30.7 |
| 55 | 61 | 32.4 | 66 | 33.5 | 70 | 33.1 | 72 | 30.0 |
| 60 | 59 | 27.2 | 64 | 28.6 | 68 | 29.9 | 71 | 28.9 |
| 65 | 56 | 23.0 | 61 | 24.5 | 65 | 25.9 | 68 | 26.5 |
| 70 | 53 | 19.7 | 59 | 21.1 | 63 | 22.4 | 67 | 23.4 |
| 75 | 50 | 16.8 | 56 | 18.2 | 61 | 19.4 | 65 | 20.4 |
| 80 | 46 | 14.2 | 53 | 15.7 | 58 | 16.9 | 63 | 17.7 |
| 85 | 42 | 12.0 | 50 | 13.4 | 56 | 14.7 | 61 | 15.6 |
| 90 | 38 | 10.2 | 47 | 11.5 | 54 | 12.8 | 59 | 13.7 |
| 95 | 34 | 8.4 | 44 | 9.9 | 52 | 11.1 | 57 | 12.0 |
| 100 | 29 | 6.9 | 41 | 8.4 | 49 | 9.5 | 54 | 10.4 |
| 110 | 13 | 4.5 | 33 | 5.9 | 43 | 7.0 | 50 | 7.9 |
| 120 | | | 23 | 3.8 | 37 | 5.0 | 45 | 5.8 |
| 130 | | | | | 28 | 3.1 | 39 | 4.1 |
| 140 | | | | | 18 | 1.7 | 32 | 2.6 |
| 150 | | | | | | | 24 | 1.2 |
| Telescoping sequence % | | | | | | | | |
| Tel. 1 | 100 | | 100 | | 100 | | 100 | |
| Tel. 2 | 100 | | 100 | | 100 | | 100 | |
| Tel. 3 | 25 | | 50 | | 75 | | 100 | |
| Tel. 4 | 25 | | 50 | | 75 | | 100 | |

Rated Lifting Capacities In 1,000 Pounds

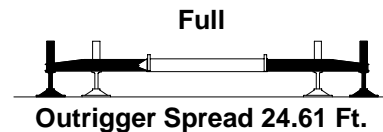
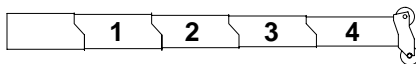
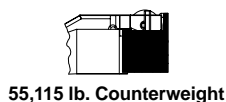

| Set Up Code #110 | | | | | | |
|------------------------|-----------|-------|-----------|-------|-----------|-------|
| Load Radius (Ft.) | 41.99 Ft. | | 57.41 Ft. | | 73.16 Ft. | |
| | ∠° | 360° | ∠° | 360° | ∠° | 360° |
| 10 | 68 | 227.0 | 75 | 193.5 | | |
| 12 | 65 | 193.5 | 72 | 188.0 | 77 | 111.5 |
| 14 | 62 | 176.0 | 70 | 173.5 | 75 | 111.5 |
| 16 | 59 | 160.5 | 68 | 158.5 | 73 | 111.5 |
| 18 | 55 | 148.0 | 66 | 146.0 | 72 | 111.5 |
| 20 | 51 | 136.5 | 64 | 134.5 | 71 | 111.5 |
| 25 | 42 | 112.5 | 58 | 110.0 | 66 | 106.5 |
| 30 | 28 | 91.5 | 51 | 88.6 | 62 | 88.7 |
| 35 | | | 45 | 67.9 | 57 | 68.3 |
| 40 | | | 37 | 54.3 | 51 | 54.7 |
| 45 | | | 26 | 44.4 | 46 | 44.8 |
| 50 | | | | | 40 | 37.2 |
| 55 | | | | | 33 | 31.1 |
| 60 | | | | | 24 | 25.9 |
| 65 | | | | | | |
| 70 | | | | | | |
| 75 | | | | | | |
| 80 | | | | | | |
| 85 | | | | | | |
| 90 | | | | | | |
| 95 | | | | | | |
| 100 | | | | | | |
| 110 | | | | | | |
| 120 | | | | | | |
| 130 | | | | | | |
| 140 | | | | | | |
| Telescoping sequence % | | | | | | |
| Tel. 1 | 0 | | 50 | | 50 | |
| Tel. 2 | 0 | | 0 | | 50 | |
| Tel. 3 | 0 | | 0 | | 0 | |
| Tel. 4 | 0 | | 0 | | 0 | |

| Set Up Code #110 | | | | | | |
|------------------------|------------|------|------------|------|------------|------|
| Load Radius (Ft.) | 104.66 Ft. | | 135.83 Ft. | | 151.57 Ft. | |
| | ∠° | 360° | ∠° | 360° | ∠° | 360° |
| 10 | | | | | | |
| 12 | | | | | | |
| 14 | | | | | | |
| 16 | | | | | | |
| 18 | 79 | 48.5 | | | | |
| 20 | 78 | 48.5 | | | | |
| 25 | 75 | 48.5 | 80 | 40.1 | | |
| 30 | 72 | 48.5 | 78 | 40.1 | 80 | 34.0 |
| 35 | 69 | 48.5 | 75 | 40.1 | 77 | 34.0 |
| 40 | 66 | 48.4 | 73 | 39.1 | 76 | 33.9 |
| 45 | 63 | 47.2 | 70 | 37.9 | 73 | 33.2 |
| 50 | 60 | 41.4 | 68 | 34.8 | 72 | 32.2 |
| 55 | 56 | 35.3 | 66 | 31.6 | 70 | 30.9 |
| 60 | 52 | 30.3 | 64 | 28.7 | 68 | 29.2 |
| 65 | 48 | 26.3 | 61 | 26.5 | 65 | 27.3 |
| 70 | 45 | 23.0 | 59 | 24.3 | 63 | 24.3 |
| 75 | 40 | 20.1 | 56 | 21.9 | 61 | 21.4 |
| 80 | 36 | 17.5 | 53 | 19.5 | 58 | 18.9 |
| 85 | 30 | 15.1 | 50 | 17.3 | 56 | 16.9 |
| 90 | 23 | 13.3 | 47 | 15.5 | 54 | 15.0 |
| 95 | 13 | 11.4 | 44 | 13.8 | 52 | 13.3 |
| 100 | | | 41 | 12.3 | 49 | 11.7 |
| 110 | | | 33 | 9.6 | 43 | 9.2 |
| 120 | | | 23 | 7.6 | 37 | 7.0 |
| 130 | | | | | 28 | 5.3 |
| 140 | | | | | 18 | 3.9 |
| Telescoping sequence % | | | | | | |
| Tel. 1 | | 50 | | 50 | | 50 |
| Tel. 2 | | 50 | | 50 | | 100 |
| Tel. 3 | | 50 | | 100 | | 100 |
| Tel. 4 | | 50 | | 100 | | 100 |

Rated Lifting Capacities In 1,000 Pounds

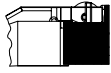

55,115 lb. Counterweight

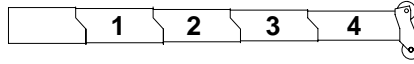

Boom Sections

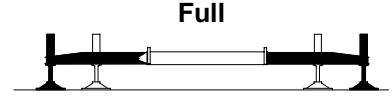

Full
Outrigger Spread 24.61 Ft.

| Set Up Code #210 | | | | | | |
|------------------------|-----------|-------|-----------|------|-----------|------|
| Load Radius (Ft.) | 41.99 Ft. | | 73.16 Ft. | | 88.91 Ft. | |
| | ∠° | 360° | ∠° | 360° | ∠° | 360° |
| 10 | 68 | 227.0 | | | | |
| 12 | 65 | 193.5 | 77 | 48.5 | | |
| 14 | 62 | 176.0 | 75 | 48.5 | 78 | 48.5 |
| 16 | 59 | 160.5 | 73 | 48.5 | 77 | 48.5 |
| 18 | 55 | 148.0 | 72 | 48.5 | 76 | 48.5 |
| 20 | 51 | 136.5 | 71 | 48.5 | 75 | 48.5 |
| 25 | 42 | 112.5 | 66 | 48.5 | 71 | 48.5 |
| 30 | 28 | 91.5 | 62 | 48.5 | 68 | 48.5 |
| 35 | | | 57 | 48.5 | 64 | 48.5 |
| 40 | | | 51 | 48.5 | 60 | 48.5 |
| 45 | | | 46 | 48.5 | 56 | 48.5 |
| 50 | | | 40 | 42.8 | 52 | 43.2 |
| 55 | | | 33 | 36.5 | 48 | 37.3 |
| 60 | | | 24 | 31.2 | 43 | 32.3 |
| 65 | | | | | 38 | 28.3 |
| 70 | | | | | 31 | 25.0 |
| 75 | | | | | 23 | 22.1 |
| 80 | | | | | 14 | 19.4 |
| 85 | | | | | | |
| 90 | | | | | | |
| 95 | | | | | | |
| 100 | | | | | | |
| 110 | | | | | | |
| 120 | | | | | | |
| Telescoping sequence % | | | | | | |
| Tel. 1 | 0 | | 0 | | 0 | |
| Tel. 2 | 0 | | 33 | | 50 | |
| Tel. 3 | 0 | | 33 | | 50 | |
| Tel. 4 | 0 | | 33 | | 50 | |

| Set Up Code #210 | | | | |
|------------------------|------------|------|------------|------|
| Load Radius (Ft.) | 104.66 Ft. | | 135.83 Ft. | |
| | ∠° | 360° | ∠° | 360° |
| 10 | | | | |
| 12 | | | | |
| 14 | | | | |
| 16 | | | | |
| 18 | 79 | 48.5 | | |
| 20 | 78 | 48.5 | | |
| 25 | 75 | 48.5 | 80 | 40.1 |
| 30 | 72 | 48.5 | 78 | 40.1 |
| 35 | 69 | 48.5 | 75 | 40.1 |
| 40 | 66 | 48.5 | 73 | 38.3 |
| 45 | 63 | 48.5 | 70 | 36.1 |
| 50 | 60 | 43.4 | 68 | 32.8 |
| 55 | 56 | 37.7 | 66 | 29.6 |
| 60 | 52 | 32.7 | 64 | 26.7 |
| 65 | 48 | 28.7 | 61 | 24.5 |
| 70 | 45 | 25.4 | 59 | 22.5 |
| 75 | 40 | 22.5 | 56 | 20.7 |
| 80 | 36 | 20.0 | 53 | 19.0 |
| 85 | 30 | 17.8 | 50 | 17.5 |
| 90 | 23 | 15.9 | 47 | 16.2 |
| 95 | 13 | 14.1 | 44 | 14.6 |
| 100 | | | 41 | 13.0 |
| 110 | | | 33 | 10.5 |
| 120 | | | 23 | 8.4 |
| Telescoping sequence % | | | | |
| Tel. 1 | 0 | | 0 | |
| Tel. 2 | 67 | | 100 | |
| Tel. 3 | 67 | | 100 | |
| Tel. 4 | 67 | | 100 | |

Rated Lifting Capacities In 1,000 Pounds

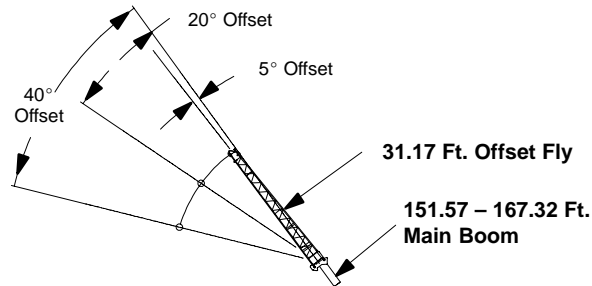
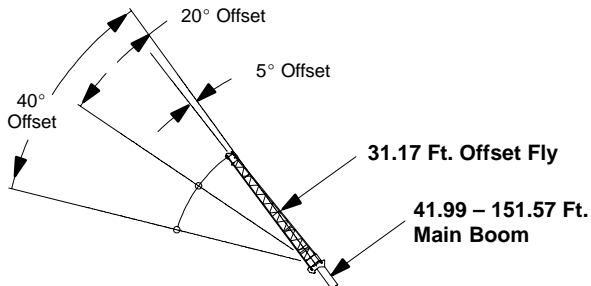
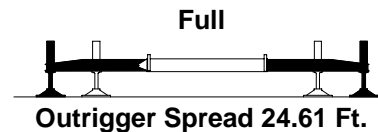
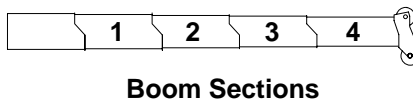

| Load Radius (Ft.) | Set Up Code #410 | | Set Up Code #411 | | Set Up Code #412 | |
|-------------------------------|------------------|------|------------------|------|------------------|------|
| | 5° Offset | | 20° Offset | | 40° Offset | |
| | ∠ | 360° | ∠ | 360° | ∠ | 360° |
| 35 | 80 | 22.0 | | | | |
| 40 | 79 | 22.0 | 81 | 18.2 | | |
| 45 | 78 | 22.0 | 80 | 18.2 | | |
| 50 | 77 | 21.6 | 79 | 17.7 | 80 | 12.6 |
| 55 | 75 | 21.0 | 77 | 17.0 | 78 | 12.4 |
| 60 | 74 | 20.4 | 76 | 16.3 | 77 | 12.1 |
| 65 | 73 | 19.9 | 74 | 15.6 | 75 | 11.8 |
| 70 | 72 | 19.4 | 73 | 15.0 | 74 | 11.5 |
| 75 | 70 | 18.8 | 71 | 14.4 | 72 | 11.2 |
| 80 | 68 | 17.7 | 69 | 14.0 | 71 | 11.0 |
| 85 | 66 | 15.5 | 67 | 13.4 | 69 | 10.7 |
| 90 | 64 | 13.5 | 66 | 12.9 | 67 | 10.5 |
| 95 | 62 | 11.7 | 64 | 12.1 | 65 | 10.3 |
| 100 | 60 | 10.1 | 62 | 10.9 | 63 | 10.1 |
| 110 | 56 | 7.5 | 58 | 8.1 | 59 | 8.7 |
| 120 | 51 | 5.4 | 53 | 5.9 | 54 | 6.4 |
| 130 | 47 | 3.5 | 48 | 4.0 | 49 | 4.2 |
| 140 | 41 | 2.0 | 43 | 2.3 | 44 | 2.4 |
| Telescoping sequence % | | | | | | |
| Tel. 1 | 100 | | | | | |
| Tel. 2 | 100 | | | | | |
| Tel. 3 | 75 | | | | | |
| Tel. 4 | 75 | | | | | |

| Load Radius (Ft.) | Set Up Code #410 | | Set Up Code #411 | | Set Up Code #412 | |
|-------------------------------|------------------|------|------------------|------|------------------|------|
| | 5° Offset | | 20° Offset | | 40° Offset | |
| | ∠ | 360° | ∠ | 360° | ∠ | 360° |
| 35 | 81 | 17.0 | | | | |
| 40 | 80 | 17.0 | 82 | 15.8 | | |
| 45 | 79 | 17.0 | 81 | 15.8 | | |
| 50 | 78 | 17.0 | 80 | 15.8 | | |
| 55 | 77 | 17.0 | 79 | 15.8 | 80 | 12.7 |
| 60 | 76 | 16.9 | 78 | 15.7 | 79 | 12.4 |
| 65 | 75 | 16.7 | 76 | 15.5 | 77 | 12.1 |
| 70 | 74 | 16.4 | 75 | 15.1 | 76 | 11.8 |
| 75 | 72 | 16.1 | 73 | 14.8 | 74 | 11.5 |
| 80 | 71 | 15.8 | 72 | 14.6 | 73 | 11.2 |
| 85 | 69 | 15.5 | 70 | 14.1 | 71 | 11.0 |
| 90 | 68 | 13.9 | 69 | 13.6 | 70 | 10.8 |
| 95 | 66 | 12.2 | 67 | 12.8 | 68 | 10.6 |
| 100 | 64 | 10.6 | 66 | 11.5 | 67 | 10.4 |
| 110 | 60 | 8.0 | 62 | 8.7 | 63 | 9.2 |
| 120 | 56 | 5.8 | 58 | 6.5 | 59 | 6.9 |
| 130 | 52 | 4.0 | 54 | 4.5 | 55 | 4.9 |
| 140 | 48 | 2.5 | 49 | 2.9 | 50 | 3.2 |
| 150 | 43 | 1.1 | 44 | 1.4 | 45 | 1.6 |
| Telescoping sequence % | | | | | | |
| Tel. 1 | 100 | | | | | |
| Tel. 2 | 100 | | | | | |
| Tel. 3 | 100 | | | | | |
| Tel. 4 | 100 | | | | | |

Rated Lifting Capacities In 1,000 Pounds

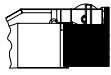

55,115 lb. Counterweight

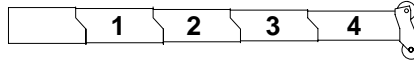

Boom Sections

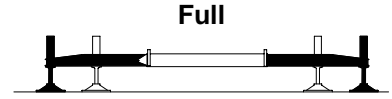

Full
Outrigger Spread 24.61 Ft.

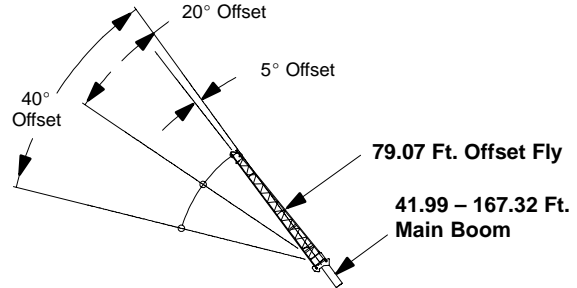
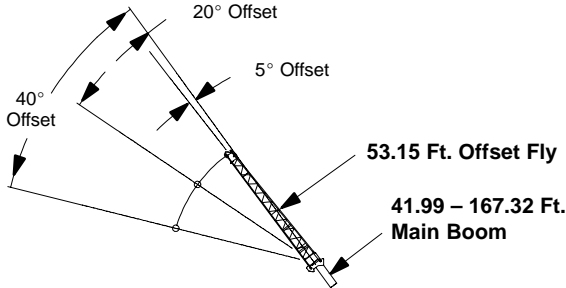

| Load Radius (Ft.) | Set Up Code #510 | | Set Up Code #511 | | Set Up Code #512 | |
|-------------------------------|------------------|------|------------------|------|------------------|------|
| | 5° Offset | | 20° Offset | | 40° Offset | |
| | Δ | 360° | Δ | 360° | Δ | 360° |
| 50 | 80 | 12.1 | | | | |
| 55 | 79 | 12.1 | 82 | 10.1 | | |
| 60 | 78 | 12.1 | 81 | 10.1 | | |
| 65 | 77 | 11.9 | 79 | 9.9 | | |
| 70 | 76 | 11.8 | 78 | 9.8 | 81 | 7.3 |
| 75 | 75 | 11.5 | 77 | 9.5 | 79 | 7.2 |
| 80 | 74 | 11.3 | 76 | 9.2 | 78 | 7.0 |
| 85 | 72 | 11.1 | 74 | 8.7 | 76 | 6.8 |
| 90 | 71 | 10.9 | 73 | 8.5 | 75 | 6.6 |
| 95 | 70 | 10.5 | 72 | 8.2 | 74 | 6.5 |
| 100 | 69 | 10.0 | 71 | 7.9 | 73 | 6.3 |
| 110 | 65 | 9.3 | 67 | 7.4 | 69 | 6.1 |
| 120 | 62 | 7.6 | 64 | 7.0 | 66 | 5.9 |
| 130 | 59 | 5.7 | 61 | 6.5 | 63 | 5.7 |
| 140 | 55 | 4.2 | 57 | 5.0 | 59 | 5.3 |
| 150 | 51 | 2.8 | 53 | 3.5 | 55 | 4.0 |
| 160 | 47 | 1.7 | 49 | 2.2 | 50 | 2.6 |
| 170 | | | | | 45 | 1.3 |
| Telescoping sequence % | | | | | | |
| Tel. 1 | | | 100 | | | |
| Tel. 2 | | | 100 | | | |
| Tel. 3 | | | 100 | | | |
| Tel. 4 | | | 100 | | | |

| Load Radius (Ft.) | Set Up Code #610 | | Set Up Code #611 | | Set Up Code #612 | |
|-------------------------------|------------------|------|------------------|------|------------------|------|
| | 5° Offset | | 20° Offset | | 40° Offset | |
| | Δ | 360° | Δ | 360° | Δ | 360° |
| 60 | 80 | 8.0 | | | | |
| 65 | 79 | 8.0 | | | | |
| 70 | 78 | 7.8 | | | | |
| 75 | 77 | 7.5 | 80 | 6.0 | | |
| 80 | 76 | 7.3 | 79 | 5.8 | | |
| 85 | 75 | 7.1 | 78 | 5.6 | 82 | 4.4 |
| 90 | 74 | 6.9 | 77 | 5.3 | 81 | 4.2 |
| 95 | 73 | 6.6 | 76 | 5.1 | 79 | 4.0 |
| 100 | 72 | 6.2 | 75 | 4.9 | 78 | 3.9 |
| 110 | 69 | 5.6 | 71 | 4.6 | 75 | 3.8 |
| 120 | 67 | 5.1 | 69 | 4.2 | 72 | 3.6 |
| 130 | 64 | 4.7 | 66 | 3.9 | 70 | 3.4 |
| 140 | 61 | 4.3 | 64 | 3.7 | 67 | 3.3 |
| 150 | 58 | 3.8 | 61 | 3.4 | 64 | 3.1 |
| 160 | 55 | 2.6 | 58 | 3.3 | 60 | 2.8 |
| 170 | 51 | 1.6 | 54 | 2.5 | 57 | 2.7 |
| 180 | | | 51 | 1.3 | 53 | 2.2 |
| 190 | | | | | 49 | 1.7 |
| Telescoping sequence % | | | | | | |
| Tel. 1 | | | 100 | | | |
| Tel. 2 | | | 100 | | | |
| Tel. 3 | | | 100 | | | |
| Tel. 4 | | | 100 | | | |

Rated Lifting Capacities In 1,000 Pounds

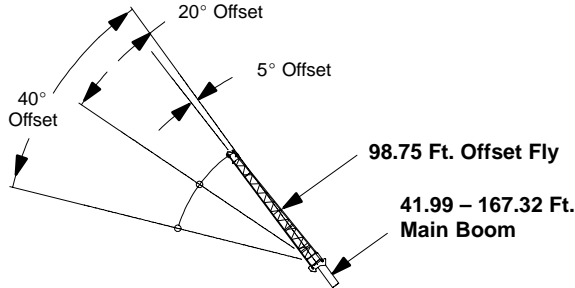
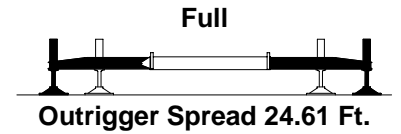
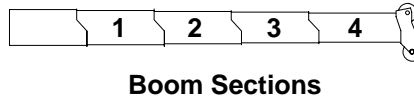
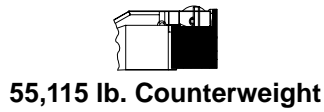

| Load Radius (Ft.) | Set Up Code #710 | | Set Up Code #711 | | Set Up Code #712 | |
|------------------------|------------------|------|------------------|------|------------------|------|
| | 5° Offset | | 20° Offset | | 40° Offset | |
| | Δ° | 360° | Δ° | 360° | Δ° | 360° |
| 60 | 81 | 5.6 | | | | |
| 65 | 80 | 5.6 | | | | |
| 70 | 79 | 5.6 | | | | |
| 75 | 79 | 5.5 | | | | |
| 80 | 78 | 5.2 | 82 | 4.5 | | |
| 85 | 77 | 5.1 | 80 | 4.3 | | |
| 90 | 76 | 4.9 | 79 | 4.1 | | |
| 95 | 75 | 4.7 | 78 | 3.9 | | |
| 100 | 74 | 4.6 | 77 | 3.7 | 82 | 3.2 |
| 110 | 71 | 4.0 | 75 | 3.4 | 79 | 2.9 |
| 120 | 69 | 3.6 | 72 | 3.1 | 77 | 2.6 |
| 130 | 67 | 3.2 | 70 | 2.8 | 74 | 2.4 |
| 140 | 65 | 3.0 | 68 | 2.6 | 72 | 2.3 |
| 150 | 62 | 2.7 | 65 | 2.3 | 69 | 2.2 |
| 160 | 60 | 2.4 | 63 | 2.2 | 66 | 2.1 |
| 170 | 57 | 2.1 | 60 | 2.0 | 63 | 1.9 |
| 180 | 54 | 1.1 | 57 | 1.8 | 60 | 1.7 |
| 190 | | | 53 | 1.2 | 56 | 1.6 |
| 200 | | | | | 53 | 1.5 |
| Telescoping sequence % | | | | | | |
| Tel. 1 | | | | 100 | | |
| Tel. 2 | | | | 100 | | |
| Tel. 3 | | | | 100 | | |
| Tel. 4 | | | | 100 | | |

